

# LM48820 Boomer® Audio Power Amplifier Series

## Ground-Referenced, Ultra Low Noise, Fixed Gain, 95mW Stereo Headphone Amplifier

### General Description

The LM48820 is a ground referenced, fixed-gain audio power amplifier capable of delivering 95mW of continuous average power into a 16 $\Omega$  single-ended load, with less than 1% THD +N from a 3V power supply.

The LM48820 features a new circuit technology that utilizes a charge pump to generate a negative reference voltage. This allows the outputs to be biased about ground, thereby eliminating output-coupling capacitors typically used with normal single-ended loads.

Boomer audio power amplifiers were designed specifically to provide high quality output power with a minimal number of external components. The LM48820 does not require output coupling capacitors or bootstrap capacitors, and therefore is ideally suited for mobile phone and other portable applications.

The LM48820 features a low-power consumption shutdown mode selectable for each channel and a soft start function that reduces start-up current transients. Additionally, the LM48820 features an internal thermal shutdown protection mechanism.

The LM48820 contains advanced pop & click circuitry that eliminates noises which would otherwise occur during turn-on and turn-off transitions.

The LM48820 has an internal fixed gain of 1.5V/V.

### Key Specifications

■ Improved PSRR at 217Hz	80dB (typ)
■ Power Output at $V_{DD} = 3V$ , $R_L = 16\Omega$ , THD+N = 1%	95mW (typ)
■ Shutdown Current	0.05 $\mu$ A (typ)
■ Internal Fixed Gain	1.5V/V (typ)
■ Wide Operating Voltage Range	1.6V to 4.5V

### Features

- Available in space saving 0.4mm pitch micro SMD package
- Fixed Logic Levels
- Ground referenced outputs
- High PSRR
- Ultra low current shutdown mode
- Improved pop & click circuitry eliminates noises during turn-on and turn-off transitions
- No output coupling capacitors, snubber networks, bootstrap capacitors, or gain-setting resistors required
- Shutdown either channel independently
- Soft start feature reduces start up transient current

### Applications

- Mobile Phones
- MP3 Players
- PDAs
- Portable electronic devices
- Notebook PCs

# Typical Application

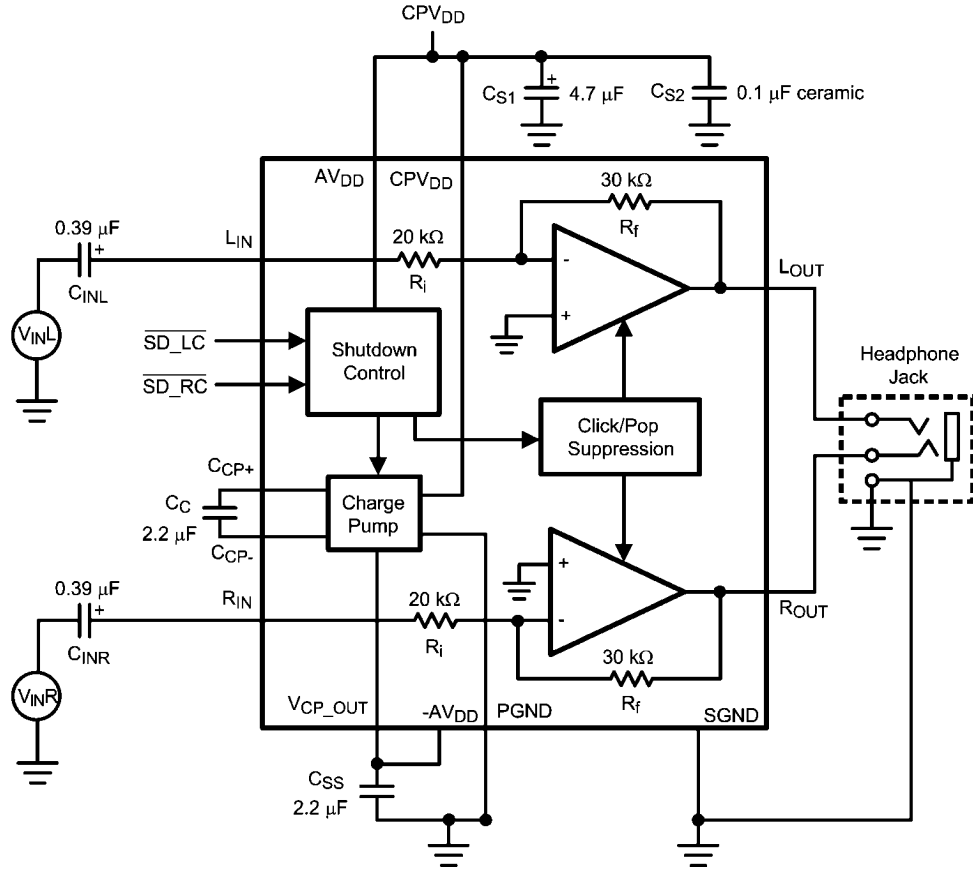

202023b8

FIGURE 1. Typical Audio Amplifier Application Circuit

# Connection Diagrams

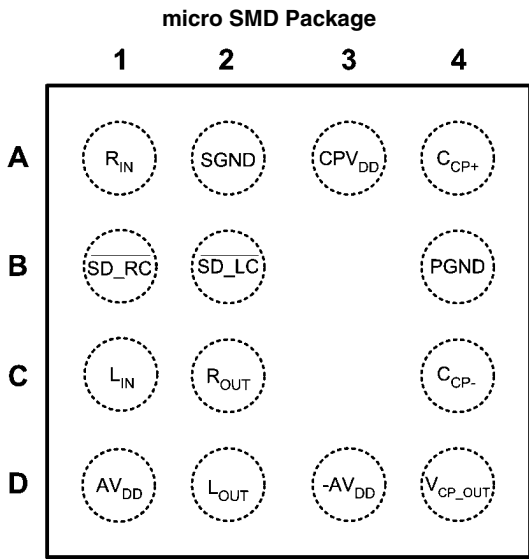

Top View  
 Order Number LM48820TM  
 See NS Package Number TME14AAA

20202309

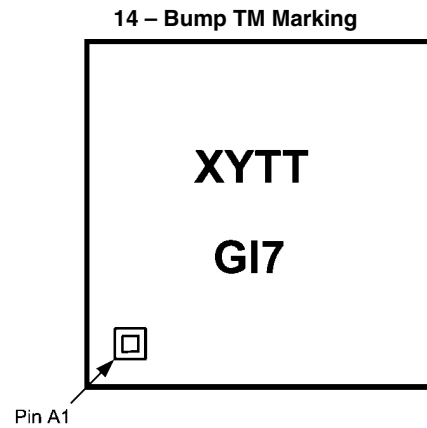

Top View  
 XY – Date Code  
 TT – Lot Traceability  
 G – Boomer Family  
 I7 – LM48820TM

20202378

TME14 Package View

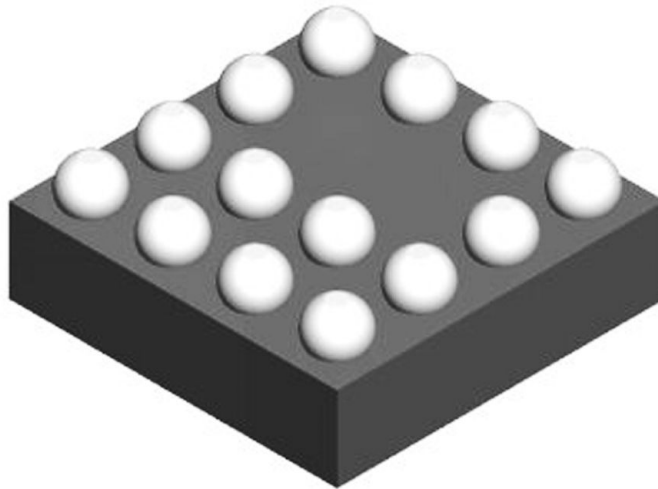

20202397

## Pin Descriptions

Pin	Name	Function
A1	$R_{IN}$	Right Channel Input
A2	SGND	Signal Ground
A3	$CPV_{DD}$	Charge Pump Power Supply
A4	$C_{CP+}$	Positive Terminal - Charge Pump Flying Capacitor
B1	$\overline{SD_{RC}}$	Active-Low Shutdown, Right Channel
B2	$\overline{SD_{LC}}$	Active-Low Shutdown, Left Channel
B4	PGND	Power Ground
C1	$L_{IN}$	Left Channel Input
C2	$R_{OUT}$	Right Channel Output
C4	$C_{CP-}$	Negative Terminal - Charge Pump Flying Capacitor
D1	$AV_{DD}$	Positive Power Supply - Amplifier
D2	$L_{OUT}$	Left Channel Output
D3	$-AV_{DD}$	Negative Power Supply - Amplifier
D4	$V_{CP\_OUT}$	Charge Pump Power Output

**Absolute Maximum Ratings** (Notes 1, 2)

If Military/Aerospace specified devices are required, please contact the National Semiconductor Sales Office/Distributors for availability and specifications.

Supply Voltage	4.75V
Storage Temperature	-65°C to +150°C
Input Voltage	-0.3V to $V_{DD} + 0.3V$
Power Dissipation (Note 3)	Internally Limited
ESD Susceptibility (Note 4)	2000V
ESD Susceptibility (Note 5)	200V

Junction Temperature	150°C
Thermal Resistance	
$\theta_{JA}$ (Note 9)	86°C/W (typ)

**Operating Ratings**

Temperature Range	
$T_{MIN} \leq T_A \leq T_{MAX}$	-40°C $\leq$ $T_A$ $\leq$ 85°C
Supply Voltage ( $V_{DD}$ )	1.6V $\leq$ $V_{DD}$ $\leq$ 4.5V

**Electrical Characteristics  $V_{DD} = 3V$**  (Notes 1, 2)

The following specifications apply for  $V_{DD} = 3V$ , 16 $\Omega$  load, and the conditions shown in "Typical Audio Amplifier Application Circuit" (see Figure 1) unless otherwise specified. Limits apply to  $T_A = 25^\circ\text{C}$ .

Symbol	Parameter	Conditions	LM48820		Units (Limits)
			Typical (Note 6)	Limit (Notes 7, 8)	
$I_{DD}$	Quiescent Power Supply Current Full Power Mode	$V_{IN} = 0V$ , inputs terminated both channels enabled	4.7	5.5	mA (max)
		$V_{IN} = 0V$ , inputs terminated one channel enabled	3		mA (max)
$I_{SD}$	Shutdown Current	$\overline{SD\_LC} = \overline{SD\_RC} = GND$	0.05	2	$\mu\text{A}$ (max)
$V_{OS}$	Output Offset Voltage	$R_L = 32\Omega$ , $V_{IN} = 0V$	1	5	mV (max)
$A_V$	Voltage Gain		-1.5		V/V
$\Delta A_V$	Gain Match		1		%
$R_{IN}$	Input Resistance		20	15 25	k $\Omega$ (min) k $\Omega$ (max)
$P_O$	Output Power	THD+N = 1% (max); f = 1kHz, one channel	95		mW
		THD+N = 1% (max); f = 1kHz, $R_L = 32\Omega$ , one channel	80		mW
		THD+N = 1% (max); f = 1kHz, two channels in phase	50	40	mW (min)
		THD+N = 1% (max); f = 1kHz, $R_L = 32\Omega$ , two channels in phase	55	45	mW (min)
THD+N	Total Harmonic Distortion + Noise	$P_O = 60\text{mW}$ , f = 1kHz, single channel	0.01		%
		$P_O = 50\text{mW}$ , f = 1kHz, $R_L = 32\Omega$ single channel	0.007		%
PSRR	Power Supply Rejection Ratio Full Power Mode	$V_{RIPPLE} = 200\text{mV}_{P-P}$ , Input Referred f = 217Hz	80		dB
		f = 1kHz	75		dB
		f = 20kHz	58		dB
SNR	Signal-to-Noise Ratio	$R_L = 32\Omega$ , $P_O = 20\text{mW}$ , (A-weighted) f = 1kHz, BW = 20Hz to 22kHz	100		dB
$V_{IH}$	Shutdown Input Voltage High	$V_{DD} = 1.8V$ to 4.2V		1.2	V (min)
$V_{IL}$	Shutdown Input Voltage Low	$V_{DD} = 1.8V$ to 4.2V		0.45	V (max)
$X_{TALK}$	Crosstalk	$P_O = 1.6\text{mW}$ , f = 1kHz	70		dB
$Z_{OUT}$	Output Impedance	$\overline{SD\_LC} = \overline{SD\_RC} = GND$ Input Terminated	30	25	k $\Omega$ (min)
		Input not terminated	30		

Symbol	Parameter	Conditions	LM48820		Units (Limits)
			Typical (Note 6)	Limit (Notes 7, 8)	
$Z_{OUT}$	Output Impedance	$\overline{SD\_LC} = \overline{SD\_RC} = GND$ $-500mV \leq V_{OUT} \leq V_{DD} + 500mV$ (Note 10)	8	2	$k\Omega$ (min)
$I_L$	Input Leakage		$\pm 0.1$		nA

**Note 1:** All voltages are measured with respect to the GND pin unless otherwise specified.

**Note 2:** Absolute Maximum Ratings indicate limits beyond which damage to the device may occur. Operating Ratings indicate conditions for which the device is functional but do not guarantee specific performance limits. Electrical Characteristics state DC and AC electrical specifications under particular test conditions that guarantee specific performance limits. This assumes that the device is within the Operating Ratings. Specifications are not guaranteed for parameters where no limit is given; however, the typical value is a good indication of device performance.

**Note 3:** The maximum power dissipation must be derated at elevated temperatures and is dictated by  $T_{JMAX}$ ,  $\theta_{JA}$ , and the ambient temperature,  $T_A$ . The maximum allowable power dissipation is  $P_{DMAX} = (T_{JMAX} - T_A) / \theta_{JA}$  or the number given in Absolute Maximum Ratings, whichever is lower. See power dissipation curves for more information.

**Note 4:** Human body model, 100pF discharged through a 1.5k $\Omega$  resistor.

**Note 5:** Machine Model, 220pF - 240pF discharged through all pins.

**Note 6:** Typical values are measured at 25°C and represent the parametric norm.

**Note 7:** Limits are guaranteed to National's AOQL (Average Outgoing Quality Level).

**Note 8:** Datasheet min/max specification limits are guaranteed by design, test, or statistical analysis.

**Note 9:**  $\theta_{JA}$  value is measured with the device mounted on a PCB with a 3" x 1.5", 1oz copper heatsink.

**Note 10:**  $V_{OUT}$  refers to signal applied to the LM48820 outputs.

## External Components Description

(Figure 1)

Components		Functional Description
1.	$C_{INR/INL}$	Input coupling capacitor which blocks the DC voltage at the amplifier's input terminals. Also creates a high-pass filter with $R_i$ at $f_C = 1/(2\pi R_i C_{IN})$ . Refer to the section <b>Proper Selection of External Components</b> , for an explanation of how to determine the value of $C_i$ .
2.	$C_C$	Flying capacitor. Low ESR ceramic capacitor ( $\leq 100m\Omega$ )
3.	$C_{SS}$	Output capacitor. Low ESR ceramic capacitor ( $\leq 100m\Omega$ )
4.	$C_{S1}$	Tantalum capacitor. Supply bypass capacitor which provides power supply filtering. Refer to the Power Supply Bypassing section for information concerning proper placement and selection of the supply bypass capacitor.
5.	$C_{S2}$	Ceramic capacitor. Supply bypass capacitor which provides power supply filtering. Refer to the Power Supply Bypassing section for information concerning proper placement and selection of the supply bypass capacitor.

# Typical Performance Characteristics

**THD+N vs Frequency**  
 $V_{DD} = 1.6V, R_L = 16\Omega, \text{Stereo}, P_O = 3mW$

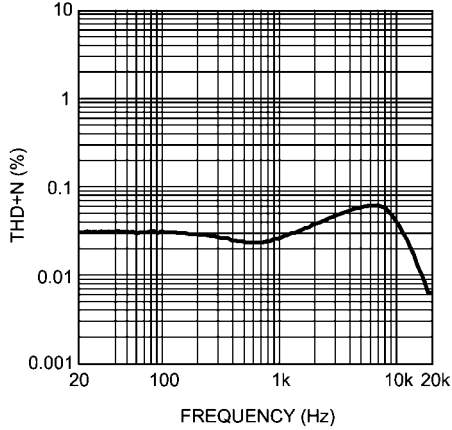

202023a0

**THD+N vs Frequency**  
 $V_{DD} = 1.6V, R_L = 32\Omega, \text{Stereo}, P_O = 3mW$

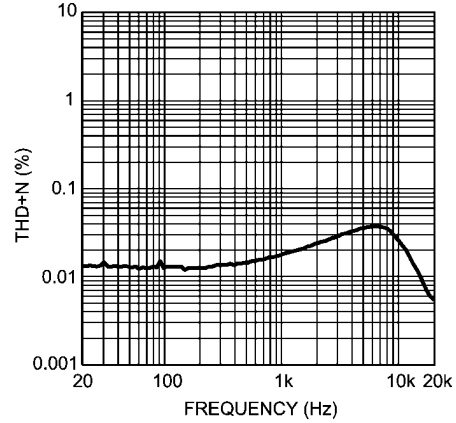

202023a1

**THD+N vs Frequency**  
 $V_{DD} = 3V, R_L = 16\Omega, \text{Stereo}, P_O = 25mW$

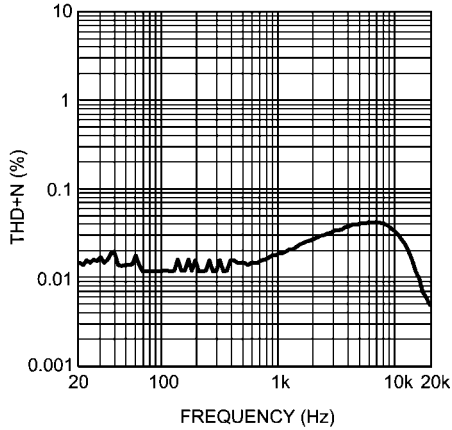

202023a3

**THD+N vs Frequency**  
 $V_{DD} = 3V, R_L = 32\Omega, \text{Stereo}, P_O = 25mW$

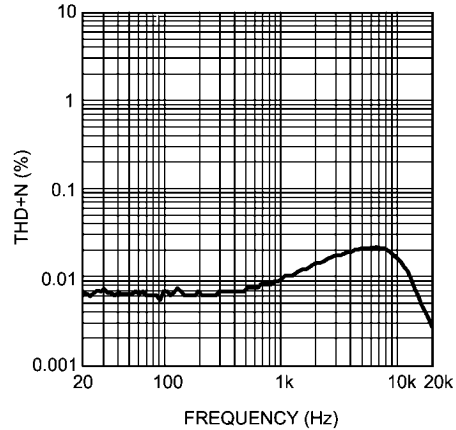

202023a5

**THD+N vs Frequency**  
 $V_{DD} = 3V, R_L = 16\Omega, \text{One channel}, P_O = 60mW$

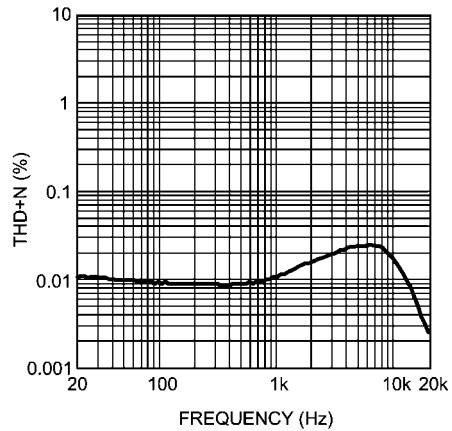

202023a2

**THD+N vs Frequency**  
 $V_{DD} = 3V, R_L = 32\Omega, \text{One channel}, P_O = 50mW$

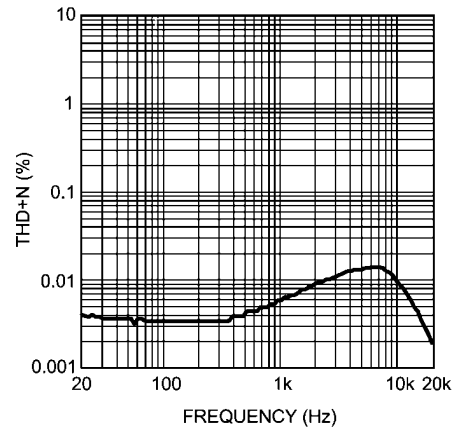

202023a4

**THD+N vs Output Power**  
 $V_{DD} = 1.6V, R_L = 16\Omega, \text{One channel}$

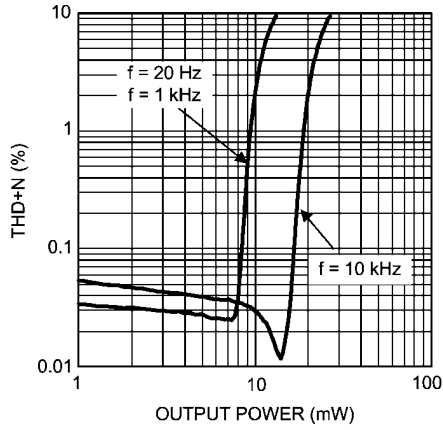

20202321

**THD+N vs Output Power**  
 $V_{DD} = 1.6V, R_L = 32\Omega, \text{One channel}$

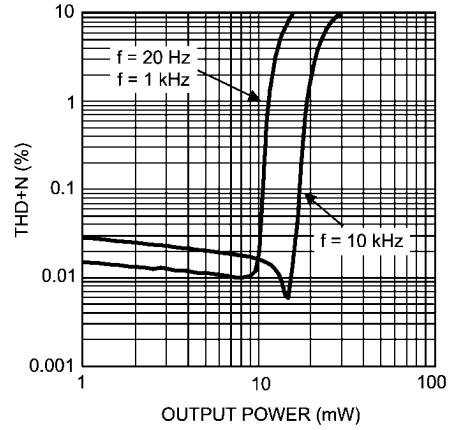

20202322

**THD+N vs Output Power**  
 $V_{DD} = 1.6V, R_L = 16\Omega, \text{Stereo}$

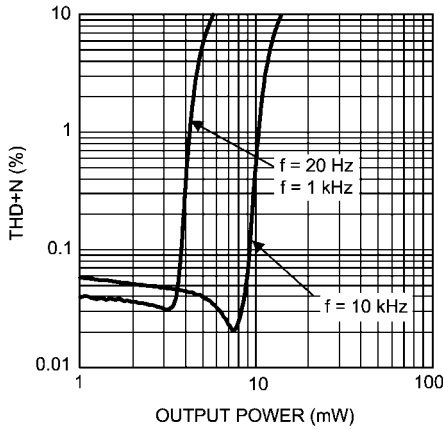

20202323

**THD+N vs Output Power**  
 $V_{DD} = 1.6V, R_L = 32\Omega, \text{Stereo}$

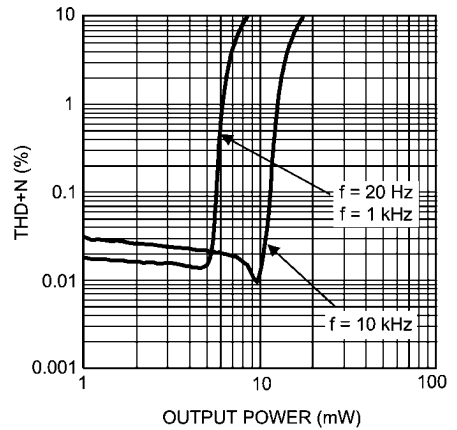

20202324

**THD+N vs Output Power**  
 $V_{DD} = 3V, R_L = 16\Omega, \text{One channel}$

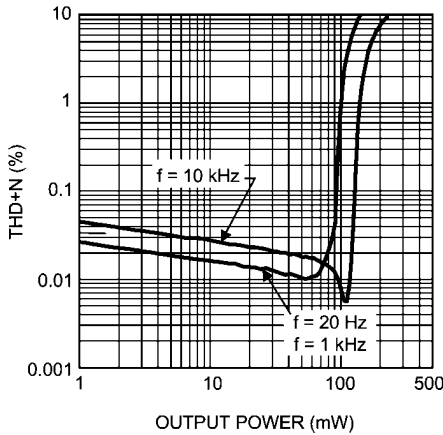

20202398

**THD+N vs Output Power**  
 $V_{DD} = 3V, R_L = 32\Omega, \text{One channel}$

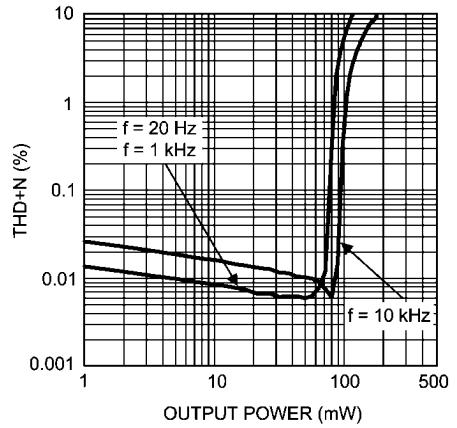

20202326



**THD+N vs Output Power**  
 $V_{DD} = 3V, R_L = 16\Omega, \text{Stereo}$

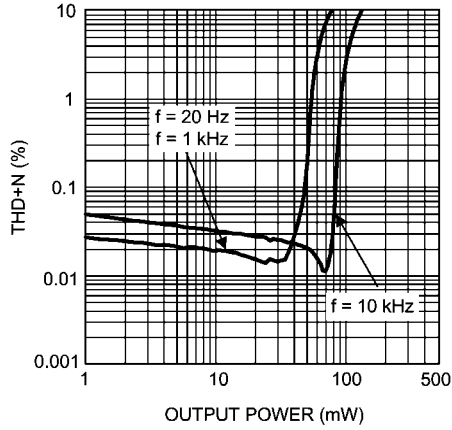

20202327

**THD+N vs Output Power**  
 $V_{DD} = 3V, R_L = 32\Omega, \text{Stereo}$

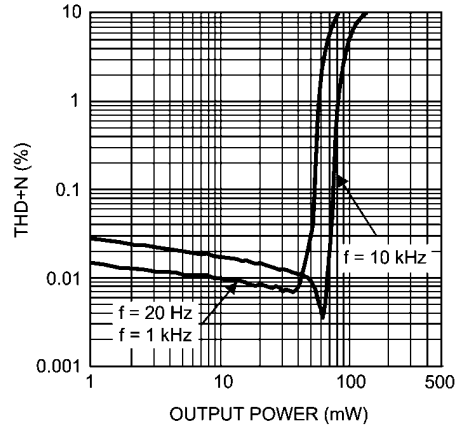

20202350

**Output Power vs Power Supply Voltage**  
 $R_L = 16\Omega, f = 1\text{kHz}, \text{Mono}$

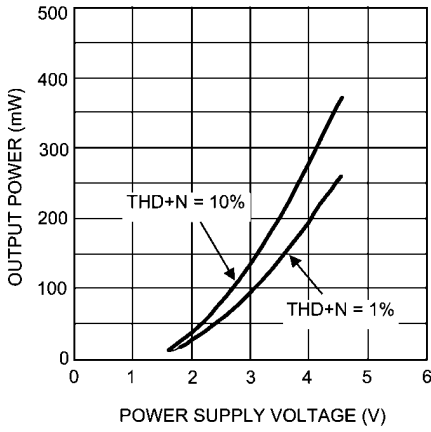

20202371

**Output Power vs Power Supply Voltage**  
 $R_L = 16\Omega, f = 1\text{kHz}, \text{Stereo}$

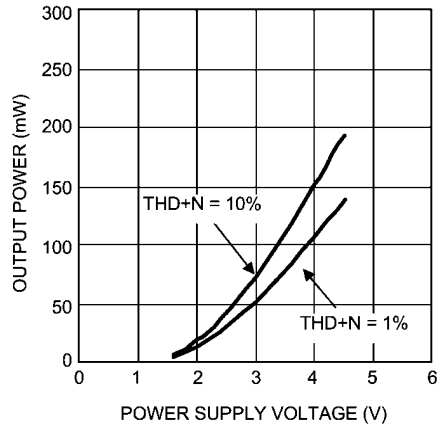

20202372

**Output Power vs Power Supply Voltage**  
 $R_L = 32\Omega, f = 1\text{kHz}, \text{Mono}$

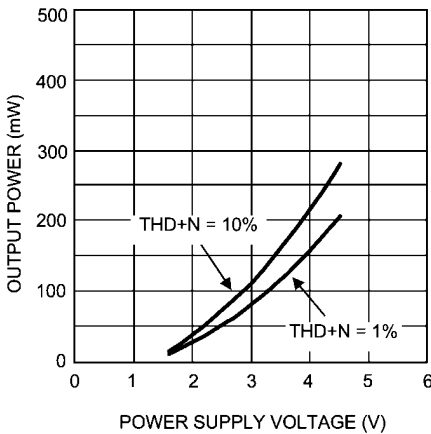

20202374

**Output Power vs Power Supply Voltage**  
 $R_L = 32\Omega, f = 1\text{kHz}, \text{Stereo}$

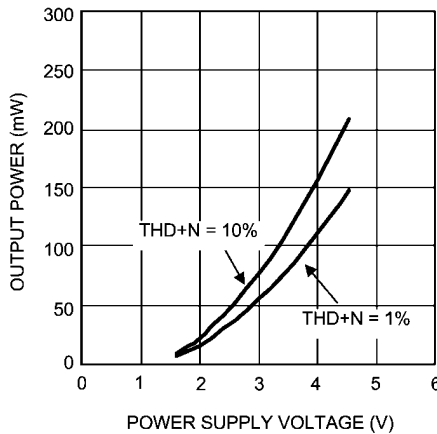

20202375

**Power Dissipation vs Output Power**  
 $V_{DD} = 1.6V, R_L = 16\Omega, f = 1kHz$

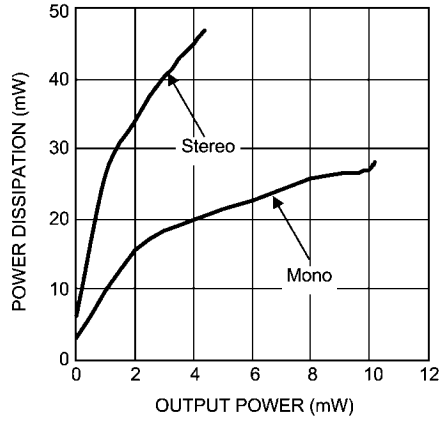

**Power Dissipation vs Output Power**  
 $V_{DD} = 1.6V, R_L = 32\Omega, f = 1kHz$

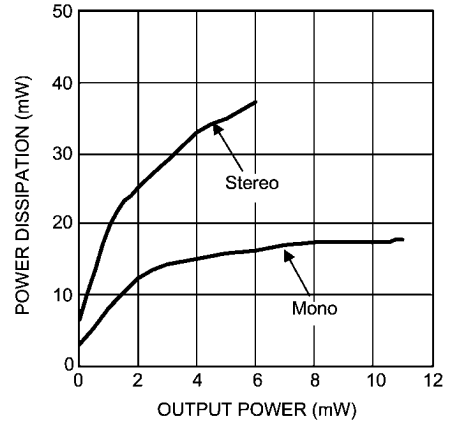

**Power Dissipation vs Output Power**  
 $V_{DD} = 3V, R_L = 16\Omega, f = 1kHz$

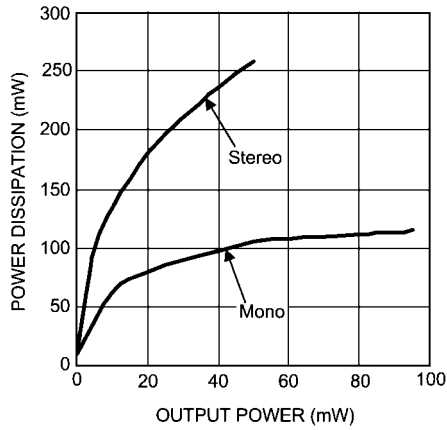

**Power Dissipation vs Output Power**  
 $V_{DD} = 3V, R_L = 32\Omega, f = 1kHz$

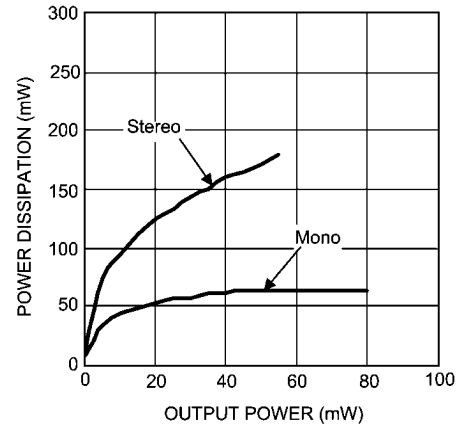

**PSRR vs Frequency**  
 $V_{DD} = 1.6V, R_L = 16\Omega$

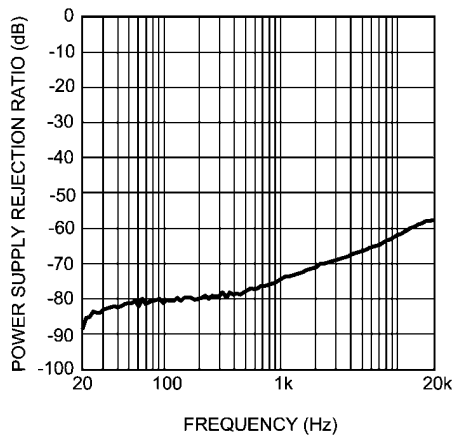

**PSRR vs Frequency**  
 $V_{DD} = 1.6V, R_L = 32\Omega$

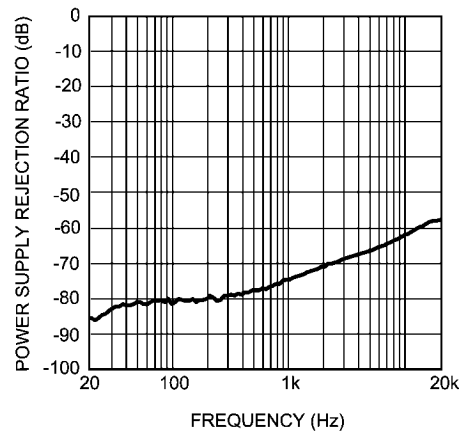

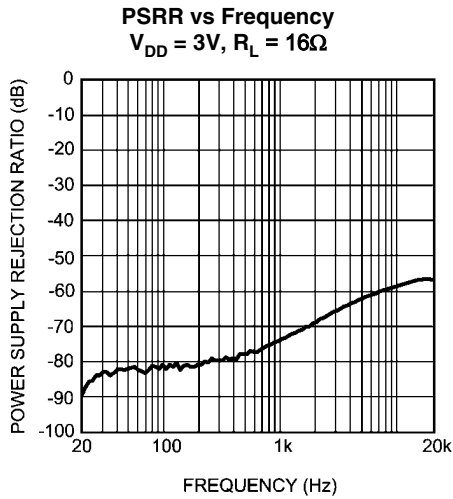

20202367

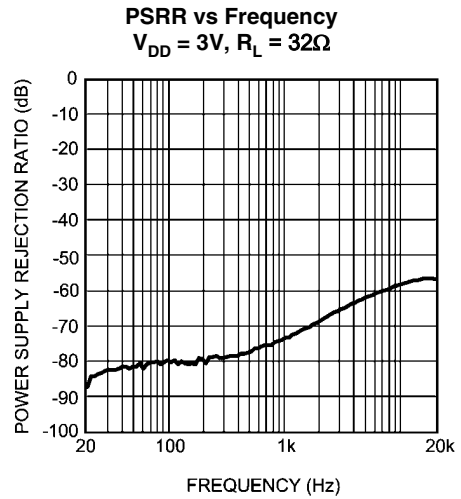

20202368

**Power Supply Current vs Power Supply Voltage**  
 $V_{IN} = 0V, \text{Mono}$

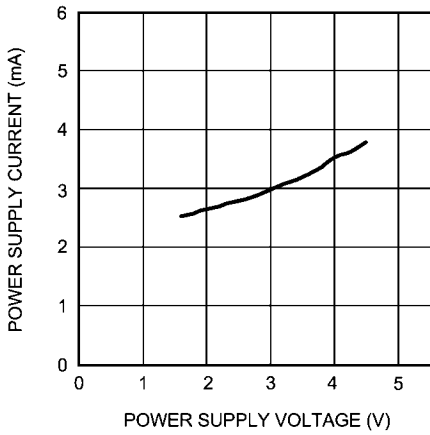

20202376

**Power Supply Current vs Power Supply Voltage**  
 $V_{IN} = 0V, \text{Stereo}$

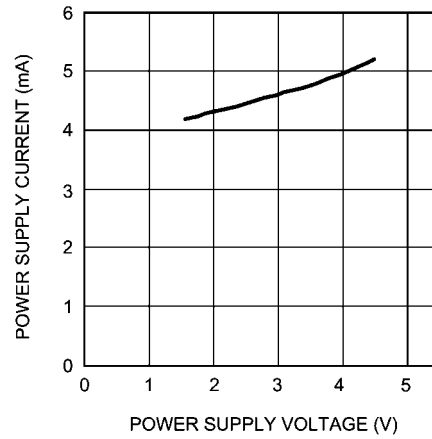

20202377

## Application Information

### SUPPLY VOLTAGE SEQUENCING

Before applying any signal to the inputs or shutdown pins of the LM48820, it is important to apply a supply voltage to the  $V_{DD}$  pins. After the device has been powered, signals may be applied to the shutdown pins (see MICRO POWER SHUTDOWN) and input pins.

### ELIMINATING THE OUTPUT COUPLING CAPACITOR

The LM48820 features a low noise inverting charge pump that generates an internal negative supply voltage. This allows the outputs of the LM48820 to be biased about GND instead of a nominal DC voltage, like traditional headphone amplifiers. Because there is no DC component, the large DC blocking capacitors (typically 220 $\mu$ F) are not necessary. The coupling capacitors are replaced by two, small ceramic charge pump capacitors, saving board space and cost.

Eliminating the output coupling capacitors also improves low frequency response. In traditional headphone amplifiers, the headphone impedance and the output capacitor form a high pass filter that not only blocks the DC component of the output, but also attenuates low frequencies, impacting the bass response. Because the LM48820 does not require the output coupling capacitors, the low frequency response of the device is not degraded by external components.

In addition to eliminating the output coupling capacitors, the ground referenced output nearly doubles the available dynamic range of the LM48820 when compared to a traditional headphone amplifier operating from the same supply voltage.

### OUTPUT TRANSIENT ('CLICK AND POPS') ELIMINATED

The LM48820 contains advanced circuitry that virtually eliminates output transients ('clicks and pops'). This circuitry prevents all traces of transients when the supply voltage is first applied or when the part resumes operation after coming out of shutdown mode.

### AMPLIFIER CONFIGURATION EXPLANATION

As shown in Figure 2, the LM48820 has two internal operational amplifiers. The two amplifiers have internally configured gain, the closed loop gain is set by selecting the ratio of  $R_f$  to  $R_i$ . Consequently, the gain for each channel of the IC is

$$A_V = -(R_f / R_i) = 1.5 \text{ (V/V)} \quad (1)$$

where  $R_f = 30\text{k}\Omega$  and  $R_i = 20\text{k}\Omega$ .

### POWER DISSIPATION

Power dissipation is a major concern when using any power amplifier and must be thoroughly understood to ensure a successful design. Equation 1 states the maximum power dissipation point for a single-ended amplifier operating at a given supply voltage and driving a specified output load.

$$P_{DMAX} = (V_{DD})^2 / (2\pi^2 R_L) \text{ (W)} \quad (2)$$

Since the LM48820 has two operational amplifiers in one package, the maximum internal power dissipation point is twice that of the number which results from Equation 2. Even with large internal power dissipation, the LM48820 does not require heat sinking over a large range of ambient temperatures. From Equation 2, assuming a 3V power supply and a 16 $\Omega$  load, the maximum power dissipation point is 28mW per

amplifier. Thus the maximum package dissipation point is 56mW. The maximum power dissipation point obtained must not be greater than the power dissipation that results from Equation 3:

$$P_{DMAX} = (T_{JMAX} - T_A) / (\theta_{JA}) \text{ (W)} \quad (3)$$

For this micro SMD package,  $\theta_{JA} = 86^\circ\text{C/W}$  and  $T_{JMAX} = 150^\circ\text{C}$ . Depending on the ambient temperature,  $T_A$ , of the system surroundings, Equation 3 can be used to find the maximum internal power dissipation supported by the IC packaging. If the result of Equation 1 is greater than that of Equation 1, then either the supply voltage must be decreased, the load impedance increased or  $T_A$  reduced. For the typical application of a 3V power supply, with a 16 $\Omega$  load, the maximum ambient temperature possible without violating the maximum junction temperature is approximately 127 $^\circ\text{C}$  provided that device operation is around the maximum power dissipation point. Power dissipation is a function of output power and thus, if typical operation is not around the maximum power dissipation point, the ambient temperature may be increased accordingly.

### POWER SUPPLY BYPASSING

As with any power amplifier, proper supply bypassing is critical for low noise performance and high power supply rejection. Applications that employ a 3V power supply typically use a 4.7 $\mu$ F capacitor in parallel with a 0.1 $\mu$ F ceramic filter capacitor to stabilize the power supply output, reduce noise on the supply line, and improve the supply's transient response. Keep the length of leads and traces that connect capacitors between the LM48820's power supply pin and ground as short as possible.

### MICRO POWER SHUTDOWN

The voltage applied to the  $\overline{\text{SD\_LC}}$  (shutdown left channel) pin and the  $\overline{\text{SD\_RC}}$  (shutdown right channel) pin controls the LM48820's shutdown function. When active, the LM48820's micropower shutdown feature turns off the amplifiers' bias circuitry, reducing the supply current. The trigger point is 0.45V (max) for a logic-low level, and 1.2V (min) for logic-high level. The low 0.05 $\mu$ A (typ) shutdown current is achieved by applying a voltage that is as near as ground as possible to the  $\overline{\text{SD\_LC}}/\overline{\text{SD\_RC}}$  pins. A voltage that is higher than ground may increase the shutdown current.

There are a few ways to control the micro-power shutdown. These include using a single-pole, single-throw switch, a microprocessor, or a microcontroller. When using a switch, connect an external 100k $\Omega$  pull-up resistor between the  $\overline{\text{SD\_LC}}/\overline{\text{SD\_RC}}$  pins and  $V_{DD}$ . Connect the switch between the  $\overline{\text{SD\_LC}}/\overline{\text{SD\_RC}}$  pins and ground. Select normal amplifier operation by opening the switch. Closing the switch connects the  $\overline{\text{SD\_LC}}/\overline{\text{SD\_RC}}$  pins to ground, activating micro-power shutdown. The switch and resistor guarantee that the  $\overline{\text{SD\_LC}}/\overline{\text{SD\_RC}}$  pins will not float. This prevents unwanted state changes. In a system with a microprocessor or microcontroller, use a digital output to apply the control voltage to the  $\overline{\text{SD\_LC}}/\overline{\text{SD\_RC}}$  pins. Driving the  $\overline{\text{SD\_LC}}/\overline{\text{SD\_RC}}$  pins with active circuitry eliminates the pull-up resistor.

### SELECTING PROPER EXTERNAL COMPONENTS

Optimizing the LM48820's performance requires properly selecting external components. Though the LM48820 operates well when using external components with wide tolerances, best performance is achieved by optimizing component values.

### Charge Pump Capacitor Selection

Use low (<100m $\Omega$ ) ESR (equivalent series resistance) ceramic capacitors with an X7R dielectric for best performance. Low ESR capacitors keep the charge pump output impedance to a minimum, extending the headroom on the negative supply. Higher ESR capacitors result in reduced output power from the audio amplifiers.

Charge pump load regulation and output impedance are affected by the value of the flying capacitor ( $C_C$ ). A larger valued  $C_C$  (up to 3.3 $\mu$ F) improves load regulation and minimizes charge pump output resistance. The switch-on resistance dominates the output impedance for capacitor values above 2.2 $\mu$ F.

The output ripple is affected by the value and ESR of the output capacitor ( $C_{SS}$ ). Larger capacitors reduce output ripple on the negative power supply. Lower ESR capacitors minimize the output ripple and reduce the output impedance of the charge pump.

The LM48820 charge pump design is optimized for 2.2 $\mu$ F, low ESR, ceramic, flying, and output capacitors.

### Input Capacitor Value Selection

Amplifying the lowest audio frequencies requires high value input coupling capacitors ( $C_{INL}$  and  $C_{INR}$  in Figure 1). A high value capacitor can be expensive and may compromise

space efficiency in portable designs. In many cases, however, the speakers used in portable systems, whether internal or external, have little ability to reproduce signals below 150Hz. Applications using speakers with this limited frequency response reap little improvement by using high value input and output capacitors.

Besides affecting system cost and size, the input coupling capacitor has an effect on the LM48820's click and pop performance. The magnitude of the pop is directly proportional to the input capacitor's size. Thus, pops can be minimized by selecting an input capacitor value that is no higher than necessary to meet the desired -3dB frequency.

As shown in Figure 1, the internal input resistor,  $R_i$  and the input capacitor,  $C_{INL}$  and  $C_{INR}$ , produce a -3dB high pass filter cutoff frequency that is found using Equation (4).

$$f_{-3dB} = 1 / 2\pi R_i C_{IN} \text{ (Hz)} \quad (4)$$

Also, careful consideration must be taken in selecting a certain type of capacitor to be used in the system. Different types of capacitors (tantalum, electrolytic, ceramic) have unique performance characteristics and may affect overall system performance.

## Revision History

Rev	Date	Description
1.0	05/09/07	Initial release.
1.1	05/15/07	Added the BOM table.
1.2	06/25/07	Deleted and replaced some curves. Input text edits also.

**Physical Dimensions** inches (millimeters) unless otherwise noted

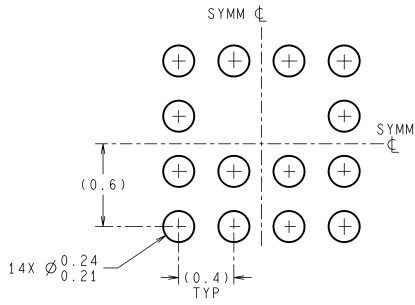

**DIMENSIONS ARE IN MILLIMETERS**  
DIMENSIONS IN ( ) FOR REFERENCE ONLY

**LAND PATTERN RECOMMENDATION**

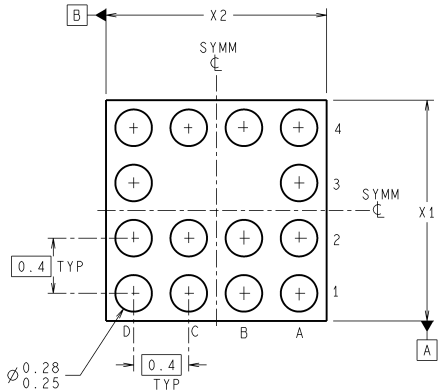
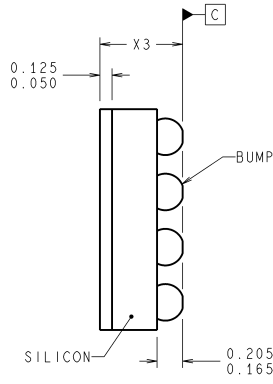
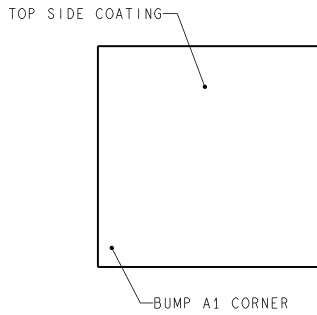

⊕	0.005	Ⓢ	C	A	Ⓢ	B	Ⓢ
---	-------	---	---	---	---	---	---

TME14XXX (Rev A)

**14 – Bump micro SMD**  
**Order Number LM48820TM**  
**NS Package Number TME14AAA**  
**X1 = X2 = 1.615±0.03mm, X3 = 0.600±0.075mm,**

## Notes

THE CONTENTS OF THIS DOCUMENT ARE PROVIDED IN CONNECTION WITH NATIONAL SEMICONDUCTOR CORPORATION ("NATIONAL") PRODUCTS. NATIONAL MAKES NO REPRESENTATIONS OR WARRANTIES WITH RESPECT TO THE ACCURACY OR COMPLETENESS OF THE CONTENTS OF THIS PUBLICATION AND RESERVES THE RIGHT TO MAKE CHANGES TO SPECIFICATIONS AND PRODUCT DESCRIPTIONS AT ANY TIME WITHOUT NOTICE. NO LICENSE, WHETHER EXPRESS, IMPLIED, ARISING BY ESTOPPEL OR OTHERWISE, TO ANY INTELLECTUAL PROPERTY RIGHTS IS GRANTED BY THIS DOCUMENT.

TESTING AND OTHER QUALITY CONTROLS ARE USED TO THE EXTENT NATIONAL DEEMS NECESSARY TO SUPPORT NATIONAL'S PRODUCT WARRANTY. EXCEPT WHERE MANDATED BY GOVERNMENT REQUIREMENTS, TESTING OF ALL PARAMETERS OF EACH PRODUCT IS NOT NECESSARILY PERFORMED. NATIONAL ASSUMES NO LIABILITY FOR APPLICATIONS ASSISTANCE OR BUYER PRODUCT DESIGN. BUYERS ARE RESPONSIBLE FOR THEIR PRODUCTS AND APPLICATIONS USING NATIONAL COMPONENTS. PRIOR TO USING OR DISTRIBUTING ANY PRODUCTS THAT INCLUDE NATIONAL COMPONENTS, BUYERS SHOULD PROVIDE ADEQUATE DESIGN, TESTING AND OPERATING SAFEGUARDS.

EXCEPT AS PROVIDED IN NATIONAL'S TERMS AND CONDITIONS OF SALE FOR SUCH PRODUCTS, NATIONAL ASSUMES NO LIABILITY WHATSOEVER, AND NATIONAL DISCLAIMS ANY EXPRESS OR IMPLIED WARRANTY RELATING TO THE SALE AND/OR USE OF NATIONAL PRODUCTS INCLUDING LIABILITY OR WARRANTIES RELATING TO FITNESS FOR A PARTICULAR PURPOSE, MERCHANTABILITY, OR INFRINGEMENT OF ANY PATENT, COPYRIGHT OR OTHER INTELLECTUAL PROPERTY RIGHT.

### LIFE SUPPORT POLICY

**NATIONAL'S PRODUCTS ARE NOT AUTHORIZED FOR USE AS CRITICAL COMPONENTS IN LIFE SUPPORT DEVICES OR SYSTEMS WITHOUT THE EXPRESS PRIOR WRITTEN APPROVAL OF THE CHIEF EXECUTIVE OFFICER AND GENERAL COUNSEL OF NATIONAL SEMICONDUCTOR CORPORATION.** As used herein:

Life support devices or systems are devices which (a) are intended for surgical implant into the body, or (b) support or sustain life and whose failure to perform when properly used in accordance with instructions for use provided in the labeling can be reasonably expected to result in a significant injury to the user. A critical component is any component in a life support device or system whose failure to perform can be reasonably expected to cause the failure of the life support device or system or to affect its safety or effectiveness.

National Semiconductor and the National Semiconductor logo are registered trademarks of National Semiconductor Corporation. All other brand or product names may be trademarks or registered trademarks of their respective holders.

Copyright© 2007 National Semiconductor Corporation

For the most current product information visit us at [www.national.com](http://www.national.com)



**National Semiconductor  
Americas Customer  
Support Center**  
Email:  
[new.feedback@nsc.com](mailto:new.feedback@nsc.com)  
Tel: 1-800-272-9959

**National Semiconductor Europe  
Customer Support Center**  
Fax: +49 (0) 180-530-85-86  
Email: [europe.support@nsc.com](mailto:europe.support@nsc.com)  
Deutsch Tel: +49 (0) 69 9508 6208  
English Tel: +49 (0) 870 24 0 2171  
Français Tel: +33 (0) 1 41 91 8790

**National Semiconductor Asia  
Pacific Customer Support Center**  
Email: [ap.support@nsc.com](mailto:ap.support@nsc.com)

**National Semiconductor Japan  
Customer Support Center**  
Fax: 81-3-5639-7507  
Email: [jpn.feedback@nsc.com](mailto:jpn.feedback@nsc.com)  
Tel: 81-3-5639-7560